

Flow Switch Fig.8050-8055-8060(MK)-8065

Product line VXS with connecting plug

Table of contents	page
0 About this operating manual	2
1 Device description	3
1.1 Intended use.....	3
1.1.1 Reed contact - Switching of inductive or capacitive loads	4
2 Safety instructions	4
2.1 Qualified personnel	4
2.2 Special safety instructions	4
3 Material specifications of wetted components	5
4 Flow switch installation	6
4.1 Mechanical installation	6
4.1.1 General installation instructions	6
4.1.2 Flow switch for direct installation (VXS01M, VXS05M, VXS06M)	6
4.1.3 Flow switch with pipe section (VXS08M-50M).....	7
4.2 Electrical connection.....	8
4.2.1 General electrical connection information	8
4.2.2 Plug connector EN 175301-803-A.....	8
5 Contact and adjusting	9
5.1 Type of contact.....	9
5.2 Adjusting the switching unit	10
6 Maintenance and repair	10
7 Decommissioning and disposal	10
8 Technical data	11

Please keep this operating manual for future reference.
 If the device is resold, please provide the operating manual along with it.

0 About this operating manual

- The operating manual is aimed at specialists and semi-skilled personnel.
- Before each step, read through the relevant advice carefully and keep to the specified order.
- Thoroughly read and understand the information in the section “Safety instructions”.

If you have any problems or questions, please contact your supplier or contact us directly at:

ERIKS bv
Cypresbaan 63
2908 LT Capelle a/d IJssel
Postbus 8988
3009 TJ Rotterdam
☎ +31 10-284 1100
✉ +31 10-251 6851
info@eriks.com

Hazard signs and other symbols used:



DANGER! Risk of death due to electric current!

This sign indicates dangers which could lead to serious health defects or to death.



WARNING! Risk of injury!

This sign indicates dangers that cause personal injuries that can lead to health defects or cause considerable damage to property.



CAUTION! Material damage!

This sign indicates actions which could lead to possible damage to material or environmental damage.



Pay attention to and comply with information that is marked with this symbol.



Follow the specified instructions and steps. Adhere to the given order.

Copyright notice:

The reproduction, distribution and utilization of this operating manual as well as the communication of its contents to others without express authorization is prohibited. Offenders will be held liable for the payment of damages. All rights reserved in the event of the grant of a patent, utility model or design.

1 Device description

ERIKS® flow switches are designed for minimum or maximum monitoring of liquid flows.

Components flow switch:

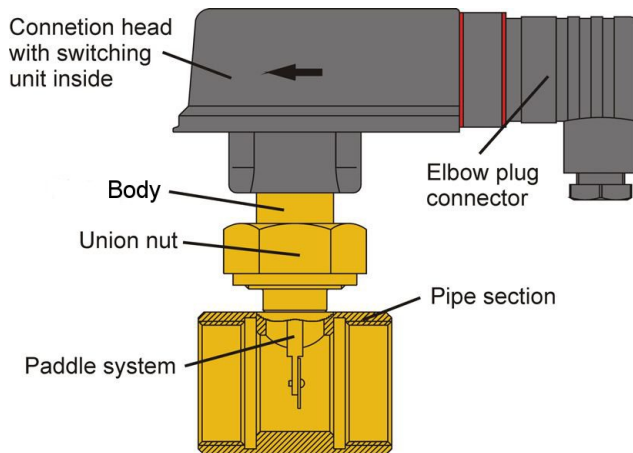

Functional principle:

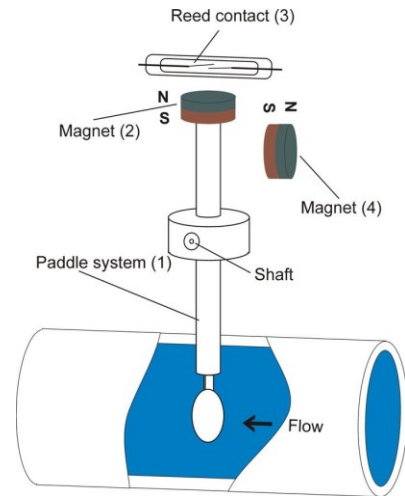

The flow switch consists of a paddle system (1) which has a permanent magnet (2) located at its upper end. A reed contact (3) is positioned outside the flow above this magnet. A second, magnet (4) with opposite polarity is used to create a reset force.

The paddle system is moved once it comes into contact with the flow which is to be monitored. The magnet (2) changes its position in relation to the reed contact (3). The contact opens/closes depending on the contact type (see chapter 5).

As soon as the flow is interrupted, the paddle returns to its original position and the reed contact opens/closes depending on the contact type (see chapter 5).

1.1 Intended use

ERIKS® flow switches are designed for minimum or maximum monitoring of liquid flows.



WARNING! No safety component!

The VXS are not safety components in accordance with Directive 2006-42-EC (Machine Directive).

⚠ Never use the VXS as a safety component.

The operational safety of the supplied instrument is only guaranteed if it is operated according to its intended use (flow monitoring of liquids). The specified limit values should never be exceeded (see "Technical data").

It is your responsibility to select a technology which is suitable for your specific application, to install it correctly, to carry out tests and to maintain all the components.

Various versions of this instrument are available. The respective type plate displays the actual version of each instrument.

1.1.1 Reed contact - Switching of inductive or capacitive loads



CAUTION! Destruction or damage of reed contact!

Take notice of the max. contact loads mentioned on the specification plate!

The max. contact loads mentioned on the type plate (switching voltage, switching current and switching capacity) refer to pure ohmic loads and may not be exceeded under any circumstances.

High voltage and current peaks can occur, particularly when switching inductive or capacitive loads (e.g. relay coil, capacitors). Even if the overload is brief, this can destroy (welding the contacts) or damage (reduced lifespan) the reed contact.

☞ Only use protection methods which be appropriate and checked.



Protection method when electrical connection of reed contacts:

The following protective circuits are basically possible: current limiting resistors, RC circuits, freewheeling diodes, suppression diodes, varistors or a combination of these.

Please verify the effectiveness of the chosen protection method in accordance with the specific loads involved.

2 Safety instructions



Before you install the VXS, read through this operating manual carefully. If the instructions contained within it are not followed, in particular the safety guidelines, this could result in danger for people, the environment, and the device and the system it is connected to.

The VXS correspond to the state-of-the-art technology. This concerns switching point accuracy, functioning and safe operation of the device.



In order to guarantee that the device operates safely, the operator must act competently and be conscious of safety issues.













ERIKS® provides support for the use of its products either personally or via relevant literature. The customer verifies that our product is fit for purpose based on our technical information. With this verification all hazards and risks are transferred to our customers; our warranty is not valid.

2.1 Qualified personnel

-  The personnel who are charged for the installation, operation and maintenance of the VXS must hold a relevant qualification. This can be based on training or relevant tuition. The personnel must be aware of this operating manual and have access to it at all times.
-  The electrical connection should only be carried out by a fully qualified electrician.

2.2 Special safety instructions

-  In all work, the existing national regulations for accident prevention and safety in the workplace must be complied with. Any internal regulations of the operator must also be complied with, even if these are not mentioned in this manual.
-  To avoid damages to the flow switch and the monitored system, only use the ERIKS® flow switch for minimum or maximum monitoring of the flow of liquids..
-  Always follow and adhere to the flow switch installation instructions.

-  Never operate the flow switch in systems which have a greater flow rate than the specified max. flow rate (see “Technical data”, details of the max. flow rate). Otherwise it will cause irreparable damage to the flow switch.
-  Prior to flow switch installation, ensure that the materials of the flow switch are chemically and mechanically resistant to the medium which is to be monitored and to all external factors.
-  Ensure that the medium is free from magnetic particles.
-  Suitable measures should be taken to prevent the medium from freezing.
If the flow switch is to be used in ambient temperatures of $<4\text{ }^{\circ}\text{C}$, do not carry out any operation beforehand with pure water, e.g. a test run. Residual water in the flow switch can result in frost damage.
-  Due to the material resistance, no lubricants, oils etc. should be used when installing the VXS...KU flow switch.
-  Ensure that the maximum specified operating pressure is not exceeded.
-  Never remove a flow switch or its body from a pipe system under pressure.
-  If the medium which is to be monitored is very hot, the flow switch or their connection fittings will also become extremely hot. In this case, neither touch the flow switch nor place any heat-sensitive objects in its vicinity.
-  Protect the flow switch against external magnetic fields in the immediate vicinity, since these can impair instrument functioning.
-  The technical data of special versions (customised versions) may differ from the data in these instructions. Please observe the information specified on the type plate.
-  **WARNING! Danger high voltages !**
De-energise the system before connecting the wires of the connecting cable.
-  It is prohibited to remove or make type plates or any other information attached to the equipment indecipherable, otherwise all warranties and the responsibility of the manufacturer no longer apply.

3 Material specifications of wetted components

Type Component	VXS..M MS (Brass)	VXS..M VA (Stainless steel)	VXS..MK MS (Brass/ Plastic)	VXS..M KU (Plastic)	VXS..M KU (Plastic)
Body	Brass 2.0401	Stainless steel 1.4571	Brass 2.0401	PPO (NORYL GFN3)	PPO (NORYL GFN3)
Paddle system	Brass 2.0401	Stainless steel 1.4571	PPO (NORYL GFN3)	PPO (NORYL GFN3)	PPO (NORYL GFN3)
Round head rivet	Brass 2.0401	Stainless steel 1.4303	-/-	-/-	-/-
Bushings	PPO (NORYL GFN3)	PVDF	PPO (NORYL GFN3)	PPO (NORYL GFN3)	PPO (NORYL GFN3)
Axle	Stainless steel 1.4571	Stainless steel 1.4571	Stainless steel 1.4571	Stainless steel 1.4571 / PPO	Stainless steel 1.4571 / PPO
Pipe section	Brass 2.0401 *)	Stainless steel 1.4571	Brass 2.0401 *)	Brass 2.0401 *)	PVC
Seal	NBR	NBR	NBR	NBR	EPDM
V Seal	-/-	-/-	EPDM	EPDM / PPO	EPDM / PPO
Magnet	Hard ferrite	Hard ferrite	Hard ferrite	Hard ferrite	Hard ferrite

*) optional copper pipe section for solder connection

4 Flow switch installation

4.1 Mechanical installation

4.1.1 General installation instructions

- ↪ When choosing the installation site, ensure that the specified limit values are not exceeded (see “Technical data”).
- ↪ Suitable measures should be taken to prevent the medium from freezing.
If the flow switch is to be used in ambient temperatures of $<4\text{ }^{\circ}\text{C}$, do not carry out any operation beforehand with pure water, e.g. a test run. Residual water in the flow switch can result in frost damage.
- ↪ Firstly, clean the pipe system in which the flow switch is to be installed and remove any magnetic particles, e.g. welding residue.
- ↪ The straight in- and outlet pipe (in front of and behind the flow switch) has to be at least $5 \times \text{DN}$.
- ↪ The nominal installation position of the flow switch is an “up-right standing position” in horizontal pipework.
- ↪ The switches should only be installed in a vertical position, deviation max. 45° (Fig. 1).
- ↪ Please contact the manufacturer if other installation positions are desired.
- ↪ Please make sure that there are no external magnetic fields in the immediate vicinity of the flow switch, since these can impair device functioning (Fig. 2a).
- ↪ There is an arrow on the flow switch. Ensure that this arrow is parallel with the pipe shaft and is facing in the direction of flow during installation (Fig. 2a).
- ↪ The brass and stainless steel union nuts $\frac{3}{4}$ “BSP (version VXS) have a tightening torque of 25...30 Nm.
- ↪ When tightening the union nuts, hold the pipe section against the surface provided (Fig. 2b).
- ↪ The plastic union nuts (version VXS...KU) have a tightening torque of 7...8 Nm.

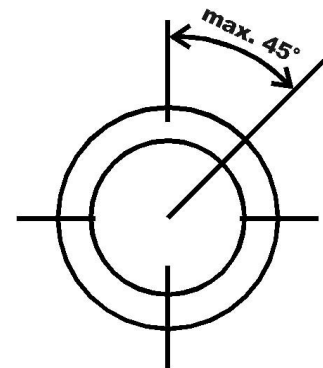

Fig. 1

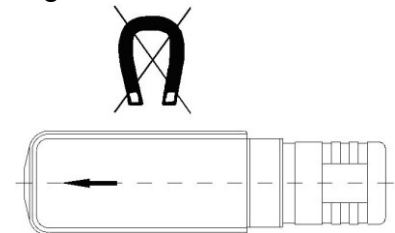

Fig. 2a



Fig. 2b

4.1.2 Flow switch for direct installation (VXS01M, VXS05M, VXS06M)

- ↪ During flow switch installation, ensure that the paddle does not touch the wall of the pipe and can move freely.
- ↪ Prior to soldering (brass) or welding (stainless steel) the threaded nipple of the flow switch VXS01M..., always disassemble the flow switch and the O-ring to prevent overheating.
- ↪ Carry out installation of your device type as described in the table below.

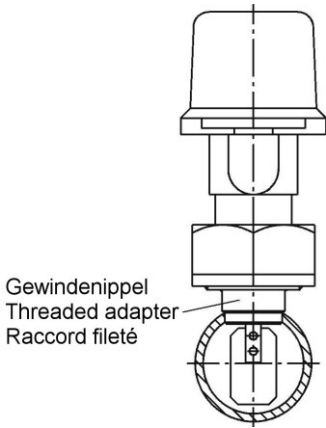
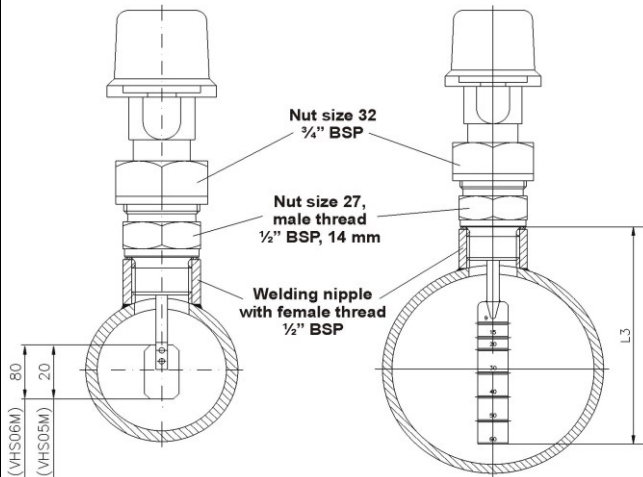
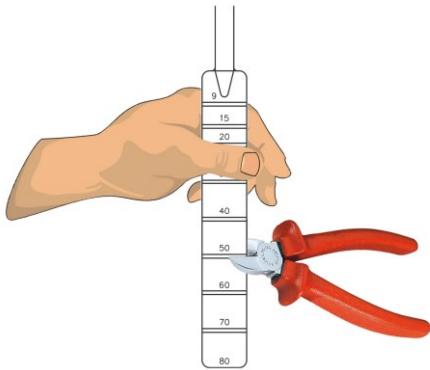
Flow switch type	Installation type and instructions
<p>VXS01M...</p>  <p>Gewindenippel Threaded adapter Raccord fileté</p> <p>Fig. 3</p>	<p>Installation with the help of brass (soldering) threaded nipples or stainless steel (welding) threaded nipples including O ring.</p>
<p>VXS05M... VXS06M... up to DN 50 VXS06MK... / VXS06M KU...</p>  <p>Nut size 32 1/4" BSP</p> <p>Nut size 27, male thread 1/2" BSP, 14 mm</p> <p>Welding nipple with female thread 1/2" BSP</p> <p>80 (VXS06M) 20 (VXS05M)</p> <p>Fig. 4</p>	<p>Installation in sockets with a 1/2" BSP female thread</p> <p>Caution: Please observe the installation height dimensions.</p> <p>VXS06MK... / VXS06M KU... (Trimmable paddle)</p> <p>Wichtig:</p> <p>Important:</p> <p>In order to shorten the paddle to the required length, use a side cutter. When cutting, hold the paddle tight above the cut surface.</p> 
<p>VXS06M... from DN 50</p>	<p>Installation in sockets with a 1/2" BSP female thread:</p> <ul style="list-style-type: none"> - horizontal pipes (switch upright) - vertical pipes. <p>Caution: Always observe the installation height dimensions.</p>

4.1.3 Flow switch with pipe section (VXS08M-50M)

- ↪ Install the flow switch pipe section just like a valve in the existing pipe.
- ↪ Sealing of the brass or stainless steel pipe sections has to be carried out with either thread sealants (Teflon tape, surface coating, etc.) or via sealing rings on the face of the tube section.

- ↪ Flow switches optionally equipped with a copper tube section (Fig. 5) have to be soldered to the pipe. The flow switch (body with paddle system) and the O-ring have to be disassembled from the tube section when soldering to prevent overheating.
- ↪ With version ...KU seal the PVC tube section (Fig. 6) in the pipe using suitable adhesive joints.

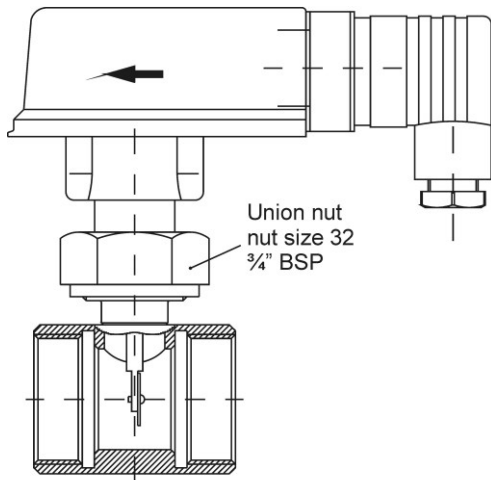

Fig. 5

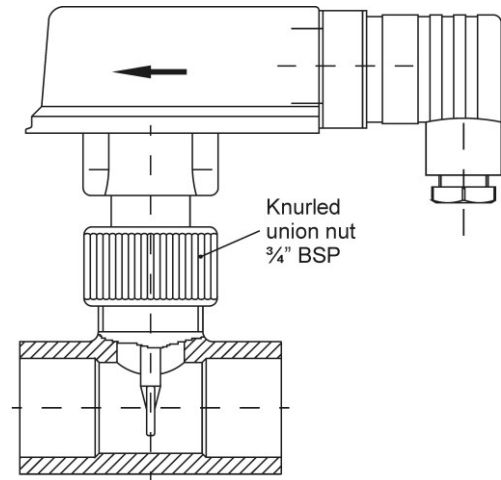

Fig. 6

4.2 Electrical connection

4.2.1 General electrical connection information



DANGER! Risk of death due to electric current!

Always de-energise the system before connecting the wires of the connecting cable.



CAUTION! Destruction or damage of reed contact!

The max. contact loads mentioned on the type plate refer to pure ohmic loads and may not be exceeded under any circumstances.

↪ Pay attention to § 1.1.1 Reed contact - Switching of inductive or capacitive loads.

4.2.2 Plug connector EN 175301-803-A

- ↪ Loosen the central screw ⑥ M3x35 and disconnect the cable socket ② from the connector ① (⇒ Fig. 5). Pull the central screw ⑥ out of the cable socket ②.
- ↪ Open the core ③ of the cable socket ② with a screwdriver or similar tool (⇒ Fig. 6).
- ↪ Loosen the screwed cable gland ⑤ M16x1,5 (⇒ Fig. 7).

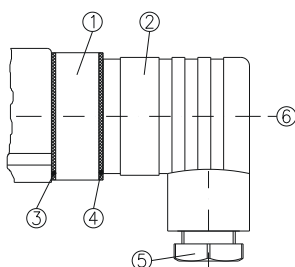

Fig. 5

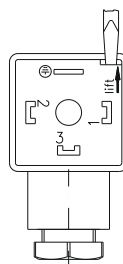

Fig. 6

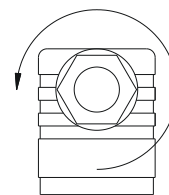

Fig. 7

- ↪ Insert the supply cable through the screwed cable gland ⑤, the pressure ring ⑩ and the rubber insert ⑨ into the cable socket ② (⇒ Fig. 8).
- ↪ Connect the wires as displayed in the connection diagram (see Fig. 11).
- ↪ Press the core ⑧ into the cable socket ② until it locks into place.
- ↪ Put the central screw ⑥ in the cable socket ② and tighten the screwed cable gland ⑤ M16x1,5 (⇒ Fig. 9).
- ↪ Plug the cable socket ② on the connector ① and tighten the central screw ⑥ (⇒ Fig. 10).

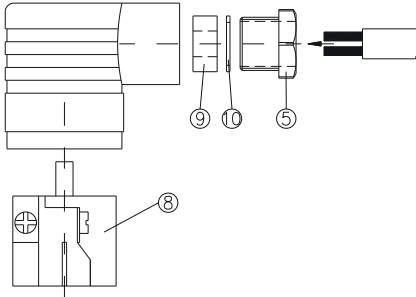

Fig. 8

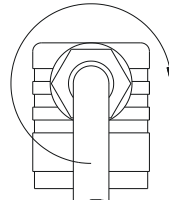

Fig. 9

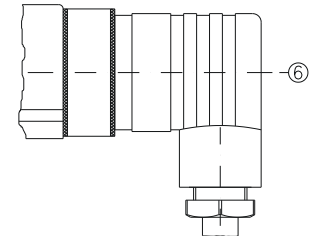

Fig. 10

- ↪ To guarantee the protection class IP 65 according to EN 60529, the connecting cable has to have a sheathing diameter of between 4.5 and 10 mm.
- ↪ Furthermore, ensure that all seals ③, ④ and ⑨ at the plug connector are inserted correctly.

Pin assignment

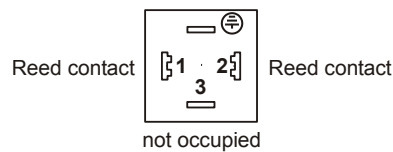
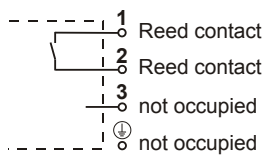

Fig. 11

5 Contact and adjusting

NOTICE:

- When a fixed switch point was set at work, then there is no adjustment of switch unit.

5.1 Type of contact

The switching unit of the control switch enables two types of contact:

1. Normally open contact: "RED" arrow on the switching unit
2. Normally closed contact: "WHITE" or "BLUE" arrow on the switching unit

The following table explains the two types of contact:

Type of contact	Setting	Filling level	Electrical contact
Normally open	RED arrow	rising	closing
		falling	opening
Normally closed	WHITE or BLUE arrow	rising	opening
		falling	closing

Unless otherwise requested by the customer, the switching is factory set as a normally open contact.

5.2 Adjusting the switching unit

- To adjust the reed switching unit, open the junction box of the switch head (Fig. 12)

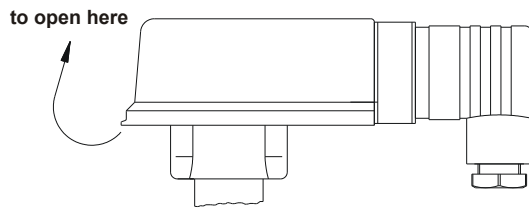

Fig.12

- Subsequently loosen the locking screw (2.5 hexa-
gon socket screw for the brass and stainless steel
version or recessed head screw for the plastic
version) and position the switching unit until the
red or white arrow are visible at the entry of the
switching contact guide for a desired make contact
(Fig. 18) or break contact (Fig. 19) respectively.
- The fine adjustment of the switching point can be
carried out on the basis of the arrow length:
Movement towards the arrow head: Switching
point is set to lower flow rate.
Movement towards the arrow tail: Switching point
is set to higher flow rate.
- Carefully retighten the locking screw.
- We recommend you to use lacquer/threadlocker to
secure the locking screw of the switching unit after
carrying out individual adjustments.
- Close the cover until it locks into place.

Normally open contact (red arrow)

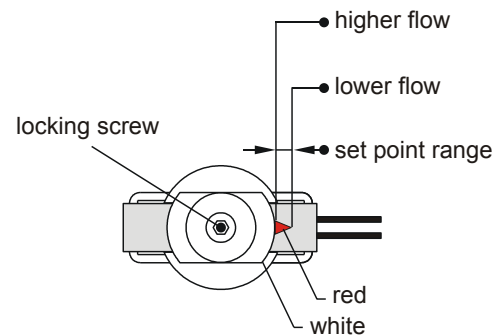

Fig. 18

Normally closed contact
(white arrow)

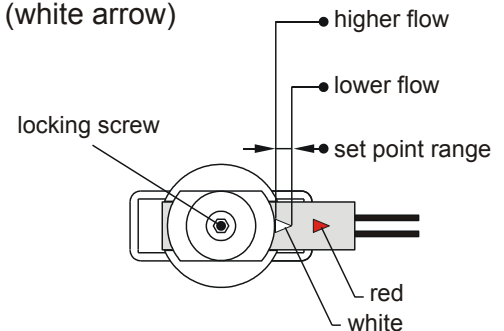

Fig. 19

6 Maintenance and repair

The flow switch is maintenance-free and cannot be repaired by the user. In the unlikely event of a defect, the instrument has to be returned to the manufacturer for repair work.

7 Decommissioning and disposal

- Never remove a flow switch or the upper part of a flow switch from a pressurised system..
- Remove all the electrical connections and dismount the flow switch.
- The flow switch consists of various materials (see Chap. 3). Never dispose of the flow switch in domestic waste (refer to the crossed out waste bin displayed on the type plate).
- Return the flow switch to the manufacturer for correct disposal.

8 Technical data

The technical data of customised versions may differ from the data in these instructions. Please observe the information specified on the type plate.

Product line	VXS...
Nominal pressure *: - Metal version VXS...MS/VA - Plastic version VXS...KU	PN 25 PN 10
Min. medium temperature:	Water +5 °C; other media -10 °C (not freezing)
Max. medium temperature: - Metal version VXS...MS/VA - Plastic version VXS05/06..KU - Plastic version VXS08-50..KU	110 °C 100 °C 20 °C (PN10); 60 °C (PN 2.5)
Min. ambient temperature: (do not store at <4 °C)	-5 °C
Max. ambient temperature:	80 °C, 100 °C (optional) 60 °C (VXS08-50..KU)
Contact rating - max. switch current - max. switch voltage - max. switch capacity	1 A 230 VAC or 48 VDC 26 VA or 20 W
Protection class	II
Degree of protection	IP 65

* Instruments with copper fittings have reduced pressure ratings.

ERIKS bv
Cypresbaan 63
2908 LT Capelle a/d IJssel
Postbus 8988
3009 TJ Rotterdam
☎ Tel. 010-284 1100
☎ Fax. 010-251 6851
@ E-mail: info@eriks.com

Technical changes reserved. 04/2012